



Cabine - Car

Linéha

Linéha	p.4
Option béton ciré <i>Polished concrete option</i>	p.12
Option Lacobel <i>Lacobel option</i>	p.20
Option impression <i>Printed Option</i>	p.24
Simply	p.26

Revêtement de sol – Floor covering

PVC (voir documentation TEINTES)
PVC (see CAR PATTERNS documentation)



Plinthes et profils de jonction des panneaux

Panel skirtings and jointing trims

Aluminium aspect inox
Natural anodized aluminium

Parois – Panels

Stratifiés ARPA, fil de bois horizontal (voir documentation TEINTES)
Laminated panels, horizontal wood (see CAR PATTERNS documentation)

Miroir – Mirror

Toute largeur, hauteur 500
Full width height 500 mm

Main courante – Handrails

- Tube : aluminium aspect inox
- Embouts : aluminium poli brillant
- Tube : aluminium, stainless steel aspect
- Ends : polished brightness aluminium

Entrée – Entrance

Retours d'entrée et vantaux en inox brossé
Entrance returns & panels in brushed stainless steel

Faux plafond – False ceiling

Époxy texturé blanc RAL 9003
White epoxy RAL 9003

Éclairage – Lighting

4 spots ronds à LED
4 round LED spots

Protection – Protection

Barrière de cellules
Safety edges

Panneau de commande – Car operating panel

Demi colonne en inox brossé M3
Half height column M3 in brushed stainless steel

Boutons et accessoires – Buttons and accessories

Boutons Cyntra noir micro-course (conforme norme EN81-70)
Indicateur d'étage LCD 4" couleur avec synthèse vocale
Téléphone tri-phonique
Digicode intégré dans la boîte à boutons
Black Cyntra micro-switch buttons (compliant to EN81-70)
4" colour LCD level display with voice synthesis
Tri-ponic telephone
Lift information printed on backlight
Integrated digital access code in the COP

Découvrez-moi
Discover me



Revêtement de sol – *Floor covering*

Céramique (voir documentation TEINTES)
Ceramic (see CAR PATTERNS documentation)



Plinthes et profils de jonction des panneaux

Panel skirtings and jointing trims

Inox -> brossé, gravé, lino, noir
Stainless steel -> brushed, engraved, lino, black

Parois – *Panels*

Lacobel, béton ciré
Lacobel, polished concrete

Miroir – *Mirror*

Toute largeur, hauteur 1000 mm
Full width height 1000 mm

Main courante – *Handrails*

- Tube : inox -> brossé
- Embouts : aluminium -> chromé, chromé ton noir, chromé ton or
- *Tube : stainless steel -> brushed*
- *Ends : aluminium -> chromium, black chromium, gold chromium*

Entrée – *Entrance*

Retours d'entrée et vantaux en inox -> gravé, lino
Entrance returns & panels in stainless steel -> engraved, lino

Faux plafond – *False ceiling*

Époxy texturé noir RAL 9005, Inox -> brossé, gravé, lino, Bat G4
Black epoxy RAL 9005, stainless steel -> brushed, polished, engraved, lino, BAT G4

Éclairage – *Lighting*

4 spots carré à LED, bande à LED
4 square LED spots, 2 LED strips

Panneau de commande – *Car operating panel*

Demi colonne inox brossé, inox poli miroir or, inox palinato, époxy brun sablé, époxy bleu chiné, Polycarbonate
Half height column in brushed stainless steel, super mirror gold stainless steel, Palinato stainless steel, brown sable epoxy, bleu chiné epoxy, polycarbonate

Boutons et accessoires – *Buttons and accessories*

Boutons Evolya Angel ou Démon, Synia micro-course (conforme norme EN81-70)
Indicateur d'étage LCD 7" avec synthèse vocale
*Evolya Angel or Démon, Synia micro switch push buttons (comply with EN 81-70)
7" LCD level display with voice synthesis*



Découvrez-moi
Discover me



Sol <i>Floor</i>	Céramique Arctic white [Option] <i>Ceramic Arctic white [Option]</i>	Main courante <i>Handrails</i>	Tube aluminium aspect inox, embout poli brillant <i>Tube aluminium stainless steel aspect, ends polished brightness aluminium</i>
Stratifié <i>Laminated panel</i>	Arpa 4514 Larix <i>Arpa 4514 Larix</i>	Miroir <i>Mirror</i>	Toute largeur hauteur 500 <i>Full width height 500 mm</i>
Faux plafond <i>False ceiling</i>	Blanc RAL 9003 avec spots carrés à LED [Option] <i>White epoxy RAL 9003 with 4 square LED spots [Option]</i>	Boîte à boutons <i>Car operating panel</i>	Demi colonne M3 en Inox brossé <i>Half height column M3 in brushed stainless steel</i>

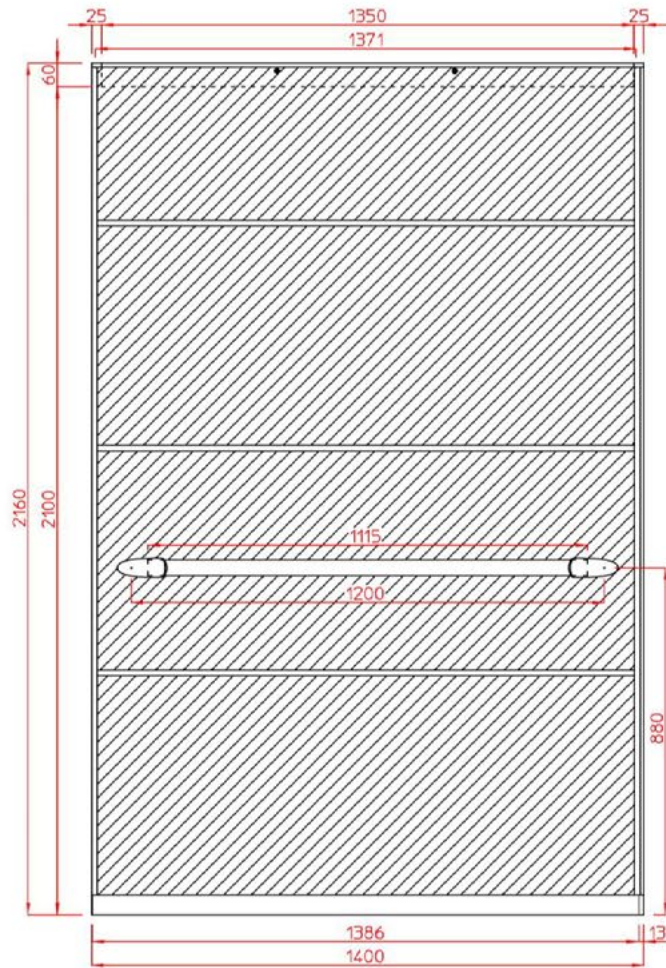

Face B

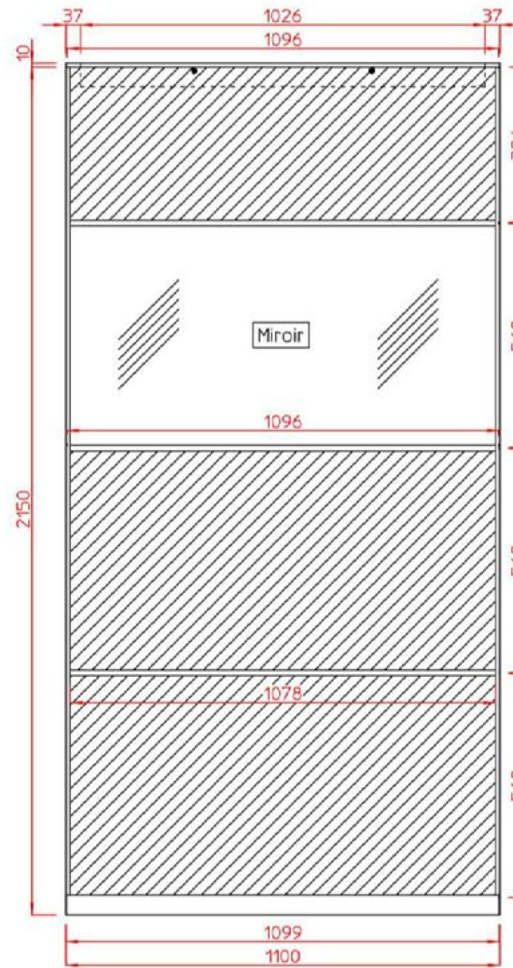



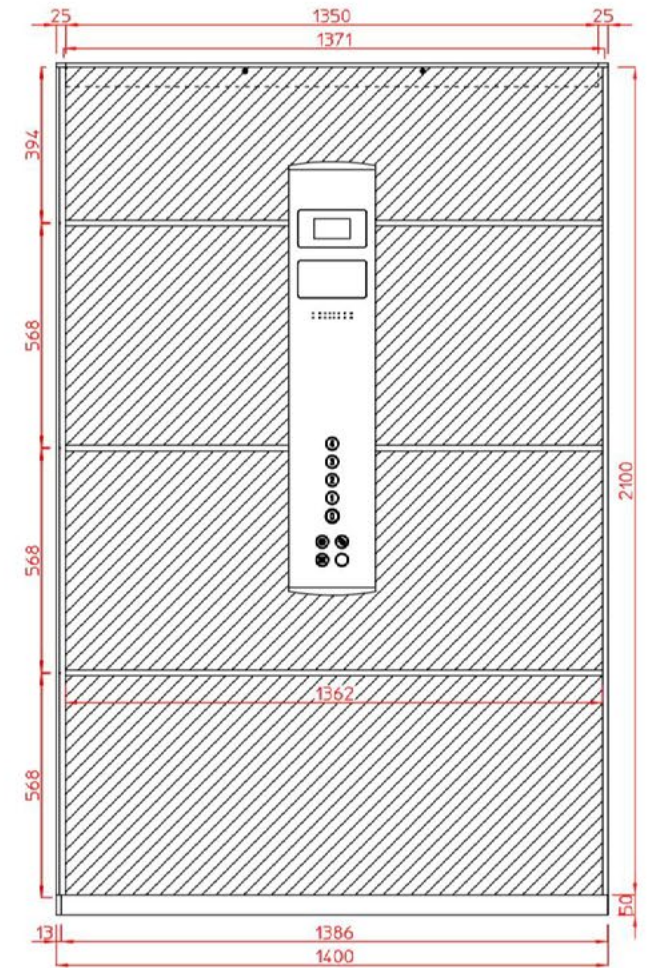

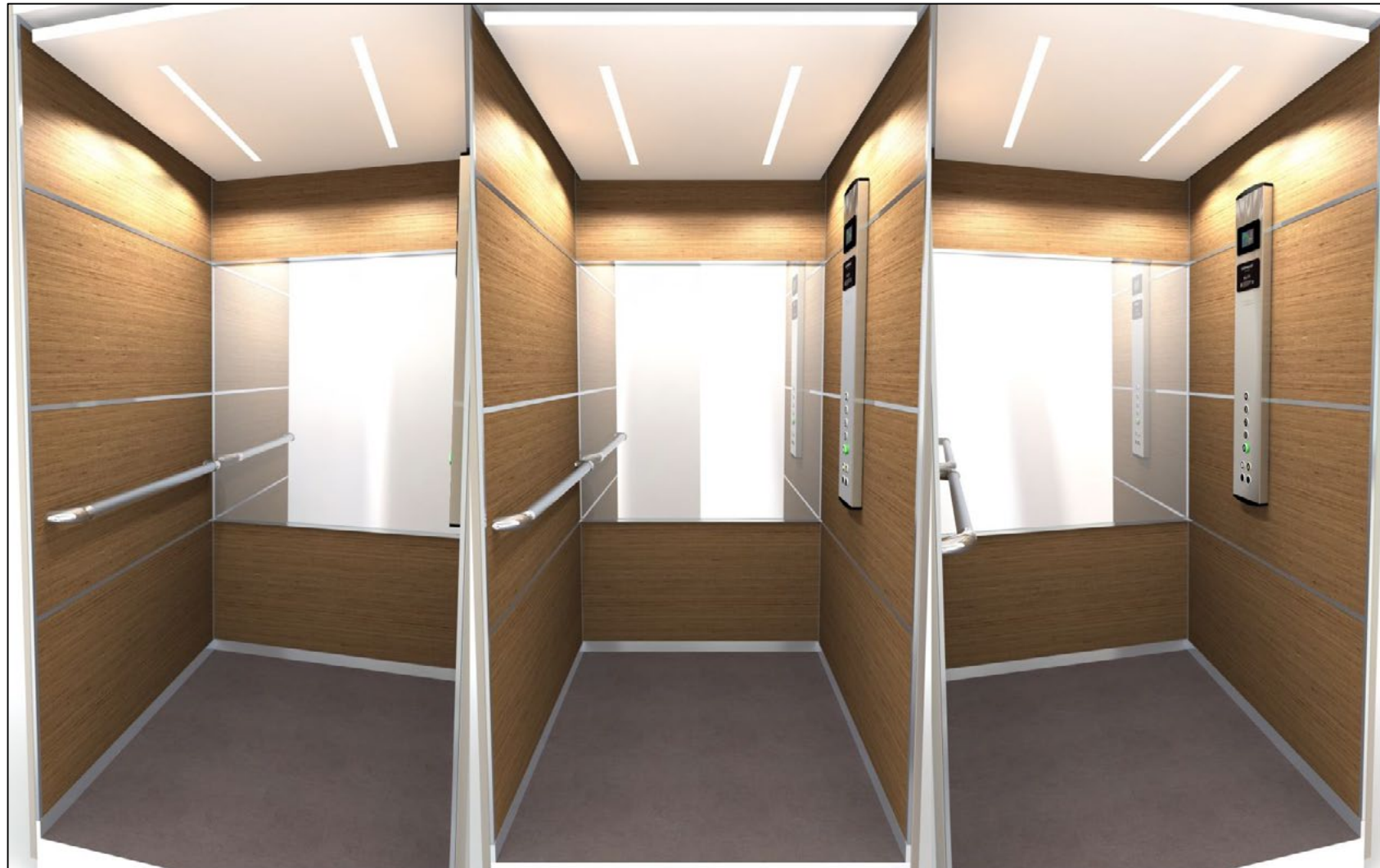

Face C



Face D



Sol <i>Floor</i>	 Tapis 0524 Cemento Modena <i>PVC - 0524 Cemento Modena</i>	Main courante <i>Handrails</i>	 Tube aluminium aspect inox, embout poli brillant <i>Tube aluminium stainless steel aspect, ends polished brightness aluminium</i>
Stratifié <i>Laminated panel</i>	 Arpa 3310 Ghibli <i>Arpa 3310 Ghibli</i>	Miroir <i>Mirror</i>	 Toute largeur hauteur 1000 [Option] <i>Full width Height 1000 mm [Option]</i>
Faux plafond <i>False ceiling</i>	 Blanc RAL 9003 avec bandes à LED [Option] <i>White epoxy RAL 9003 with LED strips [Option]</i>	Boîte à boutons <i>Car operating panel</i>	 Demi colonne M3 en Inox brossé <i>Half height column M3 in brushed stainless steel</i>



Sol
Floor

Céramique Arctic white **[Option]**
Ceramic Arctic white [Option]

Stratifié
Laminated panel

Arpa 4514 Larix
Arpa 4514 Larix

Faux plafond
False ceiling

Blanc RAL 9003 avec spots carrés à LED **[Option]**
White epoxy RAL 9003 with 4 square LED spots [Option]

Main courante
Handrails

Tube aluminium aspect inox, embout poli brillant
Tube aluminium stainless steel aspect, ends polished brightness aluminium







Miroir
Mirror

Toute largeur hauteur 500
Full width height 500 mm

Boîte à boutons
Car operating panel

Demi colonne M3 en Inox brossé
Half height column M3 in brushed stainless steel



Sol <i>Floor</i>	 Céramique Arctic white [Option] <i>Ceramic Arctic white [Option]</i>	Main courante <i>Handrails</i>	 Tube aluminium aspect inox, embout poli brillant <i>Tube aluminium stainless steel aspect, ends polished brightness aluminium</i>
Stratifié <i>Laminated panel</i>	 Arpa 0509 Pixel <i>Arpa 0509 Pixel</i>	Miroir <i>Mirror</i>	 Toute largeur hauteur 500 <i>Full width height 500 mm</i>
Faux plafond <i>False ceiling</i>	 Blanc RAL 9003 avec spots carrés à LED [Option] <i>White epoxy RAL 9003 with 4 square LED spots [Option]</i>	Boîte à boutons <i>Car operating panel</i>	 Demi colonne M3 en Inox brossé <i>Half height column M3 in brushed stainless steel</i>

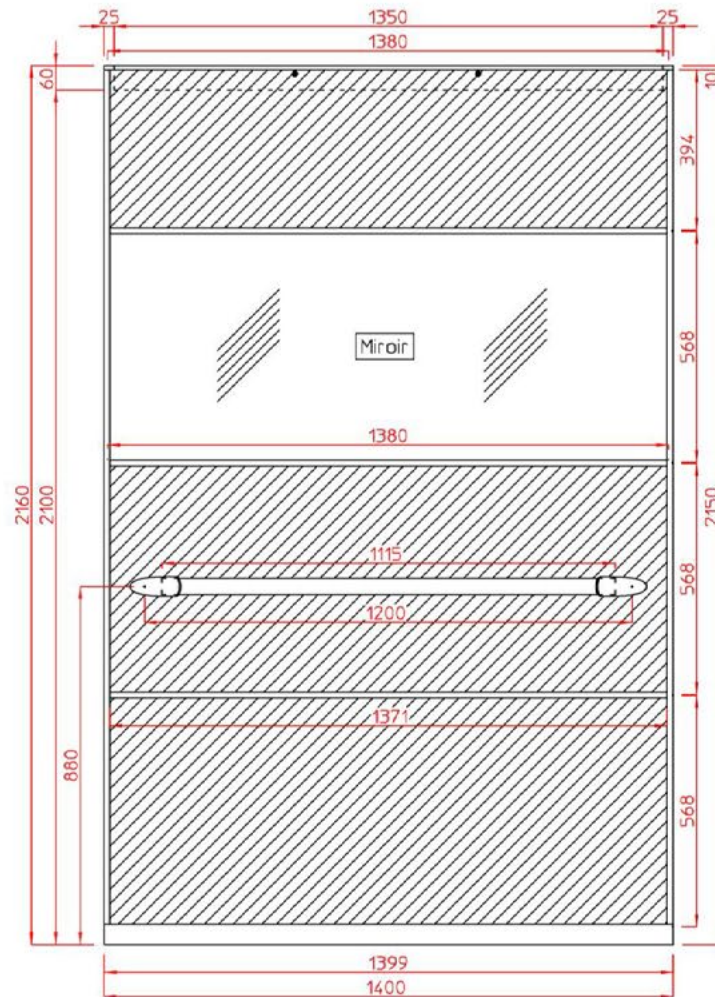

Face B

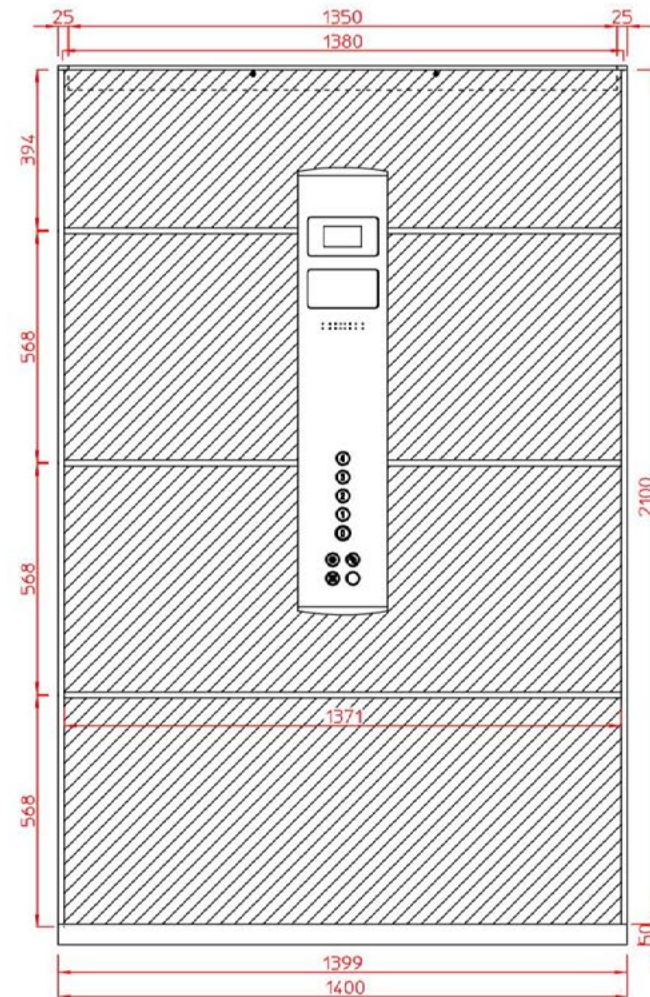

Face D



Sol
Floor

Céramique Iron frost **(Option)**
*Iron frost ceramic **(Option)***

Stratifié
Laminated panel

Arpa 4514 Larix
Arpa 4514 Larix

Faux plafond
False ceiling

Blanc RAL 9003 avec spots ronds à LED
White epoxy RAL 9003 with 4 round LED spots

Main courante
Handrails

Tube aluminium aspect inox, embout poli brillant
Tube aluminium stainless steel aspect, ends polished brightness aluminium

Miroir
Mirror

Toute largeur hauteur 1000 **(Option)**
*Full width Height 1000 mm **(Option)***

Boîte à boutons
Car operating panel

Demi colonne M3 en Inox brossé
Half height column M3 in brushed stainless steel

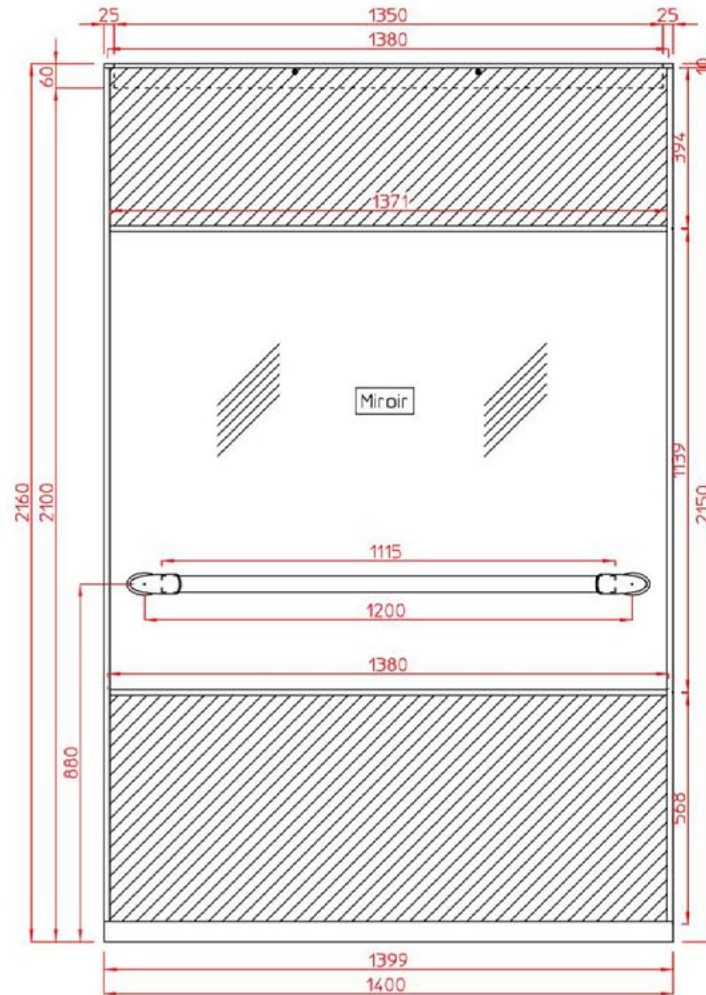

Face B

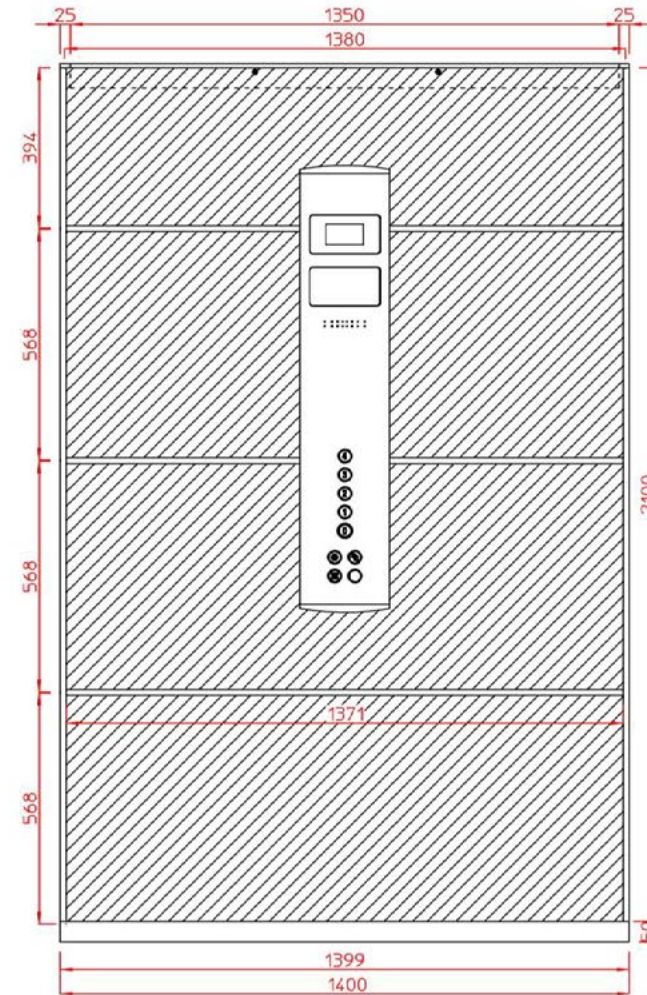

Face D

Option béton ciré – *Polished concrete option*



Sol
Floor

Tapis Urban souris
PVC - Urban souris

Stratifié
Laminated panel

Arpa 4605 Aleve + Béton ciré Ardoise **[Option]**
Arpa 4605 Aleve + Ardoise polished concrete [Option]

Faux plafond
False ceiling

Blanc RAL 9003 avec bandes à LED **[Option]**
White epoxy RAL 9003 with LED strips [Option]

Main courante
Handrails

Tube aluminium aspect inox, embout poli brillant
Tube aluminium stainless steel aspect, ends polished brightness aluminium

Miroir
Mirror

Toute largeur hauteur 500
Full width height 500 mm

Boîte à boutons
Car operating panel

Demi colonne M3 en Inox brossé
Half height column M3 in brushed stainless steel

Option béton ciré – *Polished concrete option*

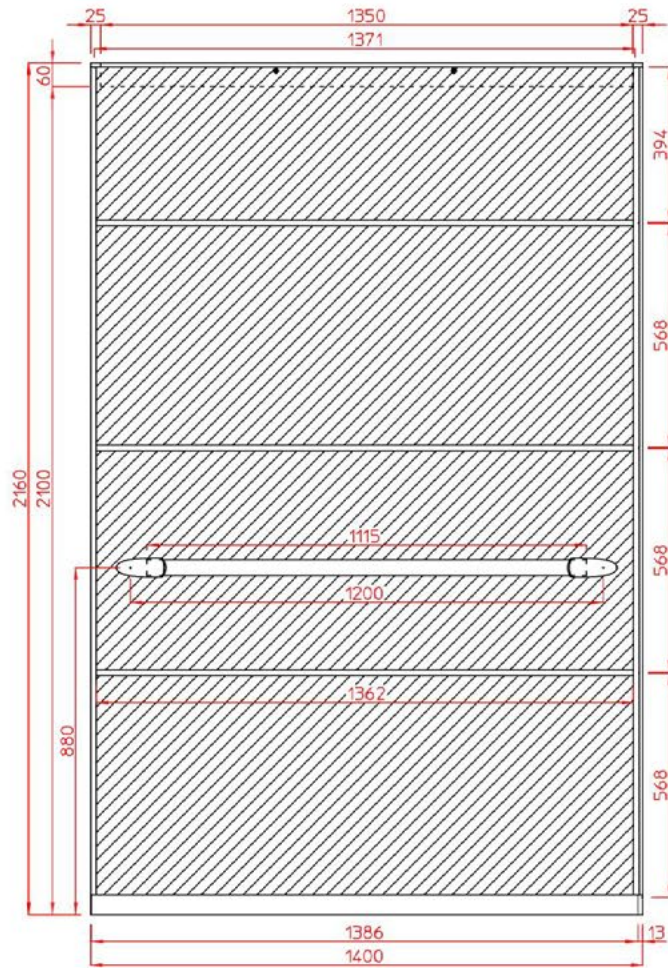

Face B

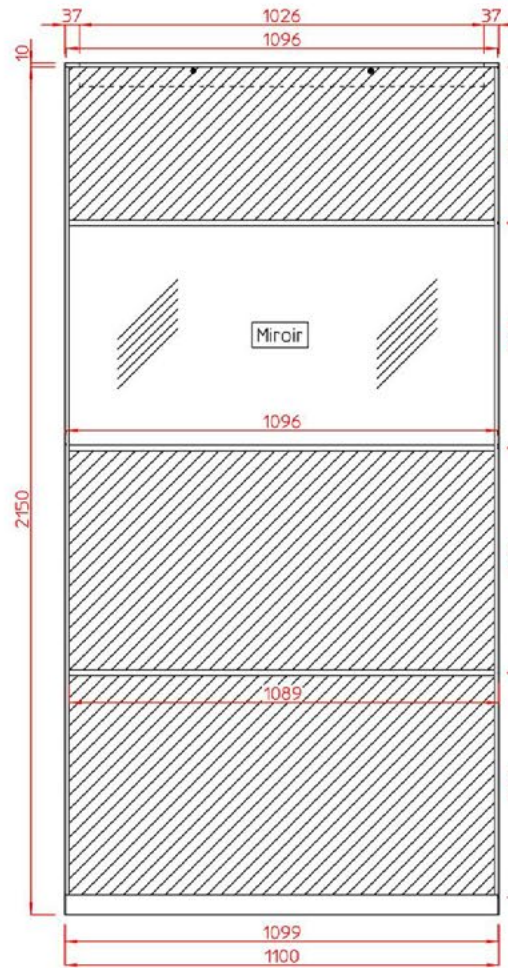

Face C

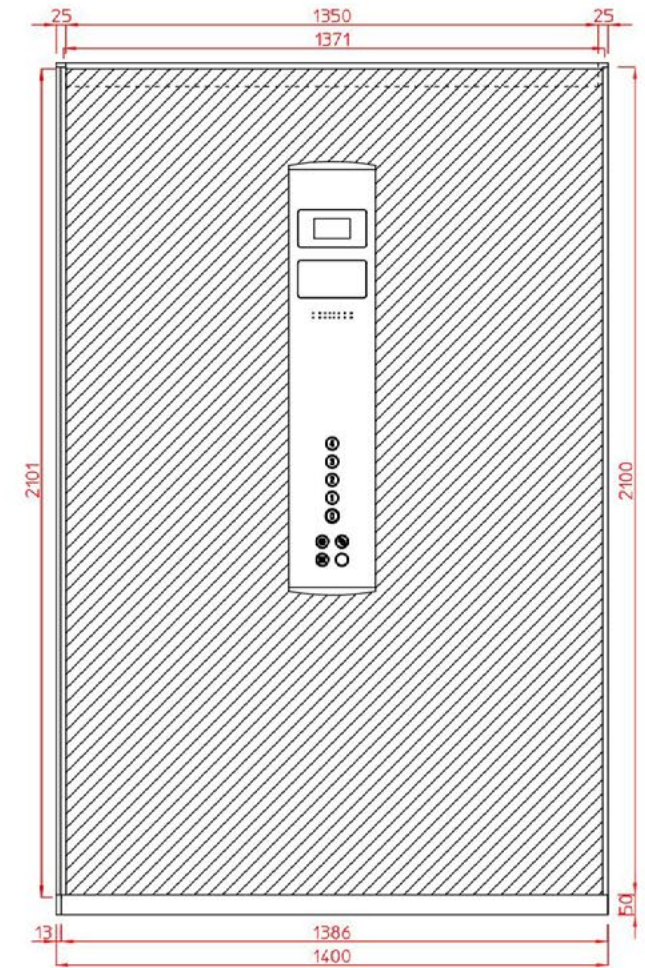

Face D

Option béton ciré – *Polished concrete option*



Sol
Floor

Tapis 0524 Cemento Modena
PVC - 0524 Cemento Modena

Stratifié
Laminated panel

Abet 669 + béton ciré cendré **[Option]**
Abet 669 + cendre polished concrete [Option]

Faux plafond
False ceiling

Blanc RAL 9003 avec spots ronds à LED
White epoxy RAL 9003 with 4 round LED spots

Main courante
Handrails

Tube aluminium aspect inox, embout poli brillant
Tube aluminium stainless steel aspect, ends polished brightness aluminium

Miroir
Mirror

Toute largeur hauteur 1000 **[Option]**
Full width Height 1000 mm [Option]

Boîte à boutons
Car operating panel

Demi colonne M3 en Inox brossé
Half height column M3 in brushed stainless steel

Option béton ciré – *Polished concrete option*

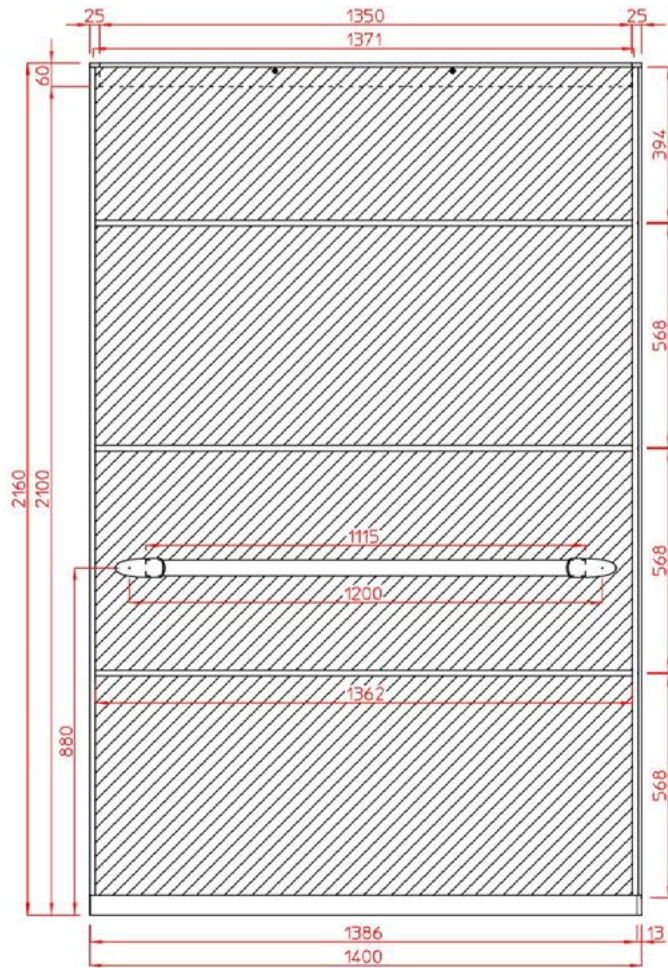

Face B

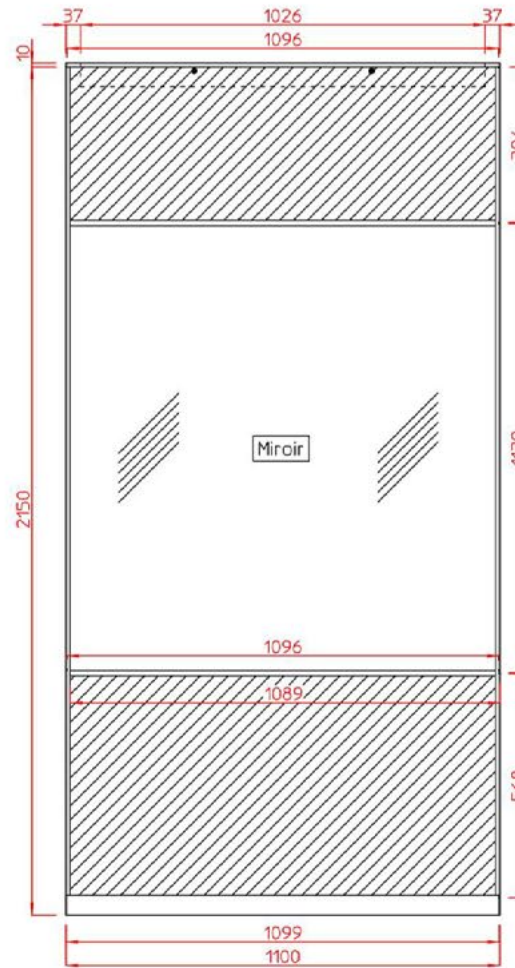

Face C

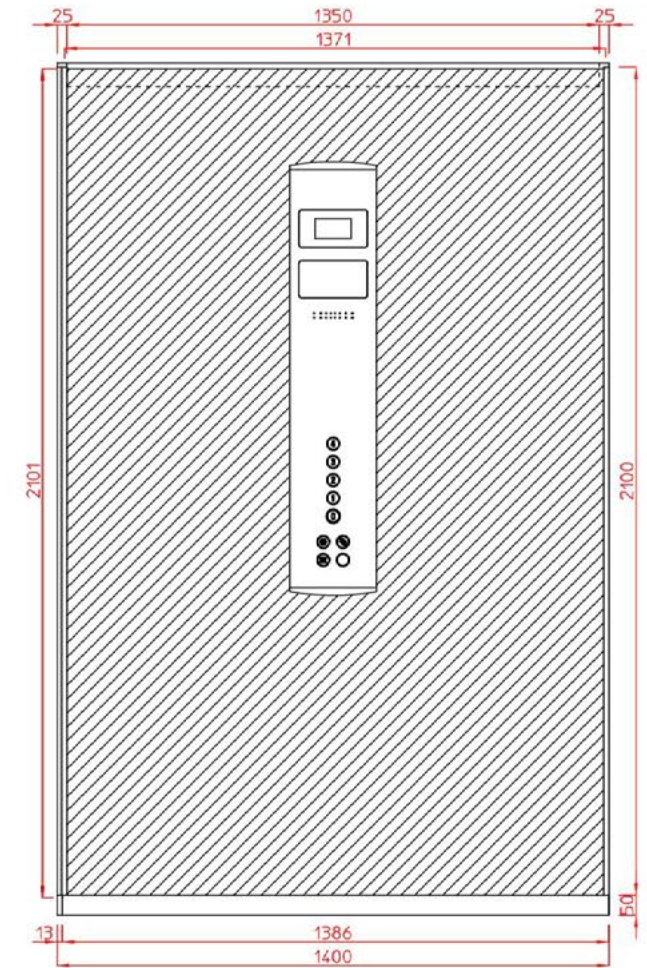

Face D

Option béton ciré – *Polished concrete option*



Sol <i>Floor</i>	Céramique calacatta [Option] <i>calacatta ceramic [Option]</i>	Main courante <i>Handrails</i>	Tube aluminium aspect inox, embout poli brillant <i>Tube aluminium stainless steel aspect, ends polished brightness aluminium</i>
Stratifié <i>Laminated panel</i>	Abet 1804 + béton ciré maluchite [Option] <i>Abet 1804 + maluchite polished concrete [Option]</i>	Miroir <i>Mirror</i>	Toute largeur hauteur 500 <i>Full width height 500 mm</i>
Faux plafond <i>False ceiling</i>	Blanc RAL 9003 avec bandes à LED [Option] <i>White epoxy RAL 9003 with LED strips [Option]</i>	Boîte à boutons <i>Car operating panel</i>	Demi colonne M3 en Inox brossé <i>Half height column M3 in brushed stainless steel</i>

Option béton ciré – *Polished concrete option*

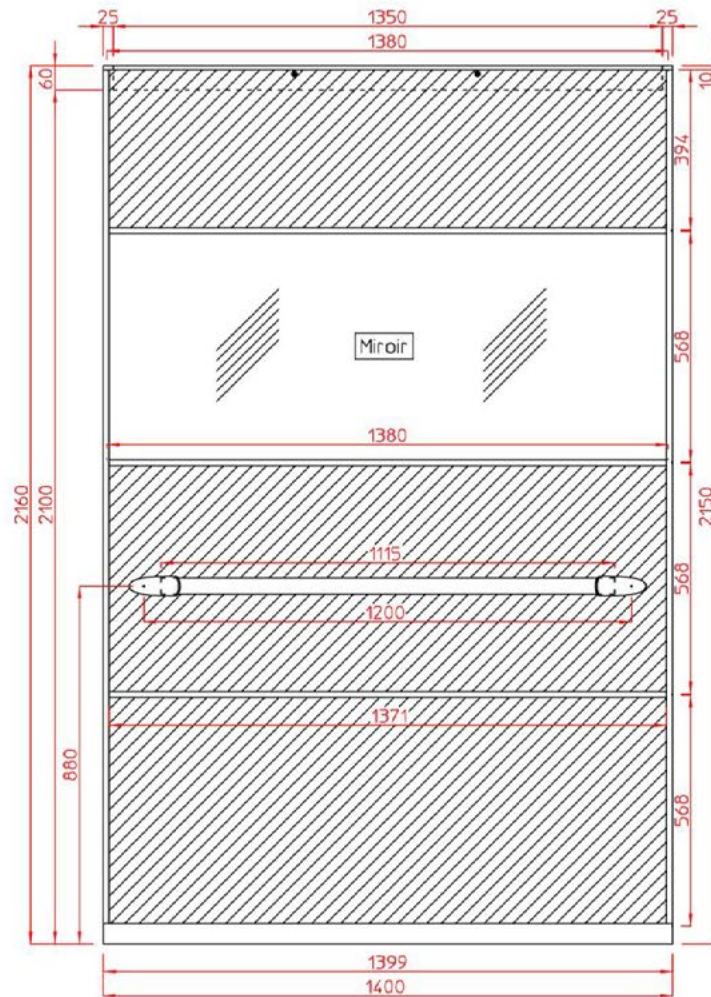

Face B

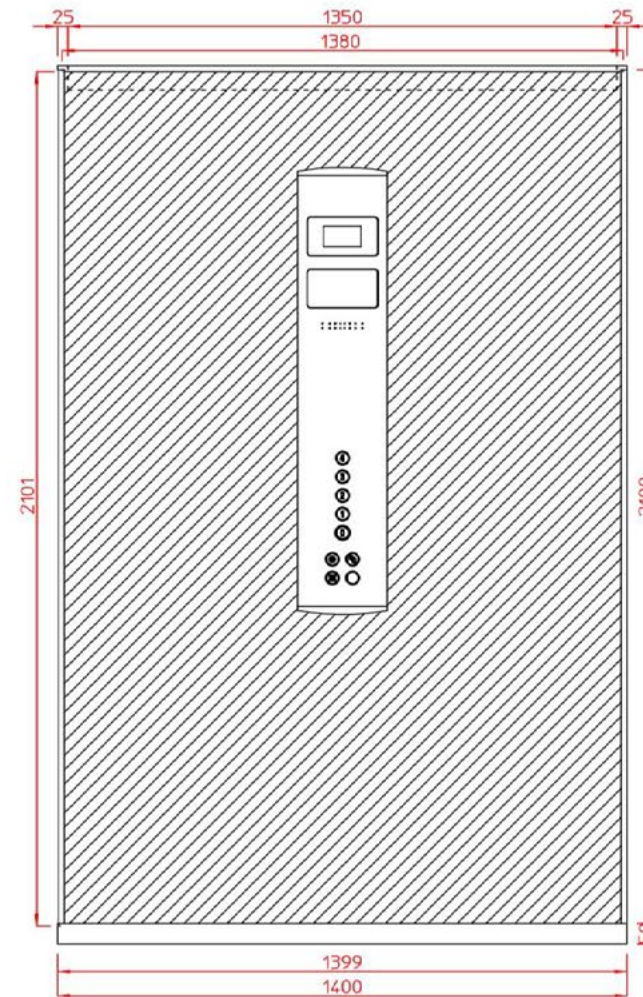

Face D

Option béton ciré – *Polished concrete option*



Sol <i>Floor</i>	Céramique Iron frost [Option] <i>Iron frost ceramic [Option]</i>	Main courante <i>Handrails</i>	Tube aluminium aspect inox, embout poli brillant <i>Tube aluminium stainless steel aspect, ends polished brightness aluminium</i>
Stratifié <i>Laminated panel</i>	Arpa 669 Larix + béton ciré marne bleu [Option] <i>Arpa 669 Larix + marne bleu polished concrete [Option]</i>	Miroir <i>Mirror</i>	Toute largeur hauteur 1000 [Option] <i>Full width Height 1000 mm [Option]</i>
Faux plafond <i>False ceiling :</i>	Blanc RAL 9003 avec spots ronds à LED <i>White epoxy RAL 9003 with 4 round LED spots</i>	Boîte à boutons <i>Car operating panel</i>	Demi colonne M3 en Inox brossé <i>Half height column M3 in brushed stainless steel</i>

Option béton ciré – *Polished concrete option*

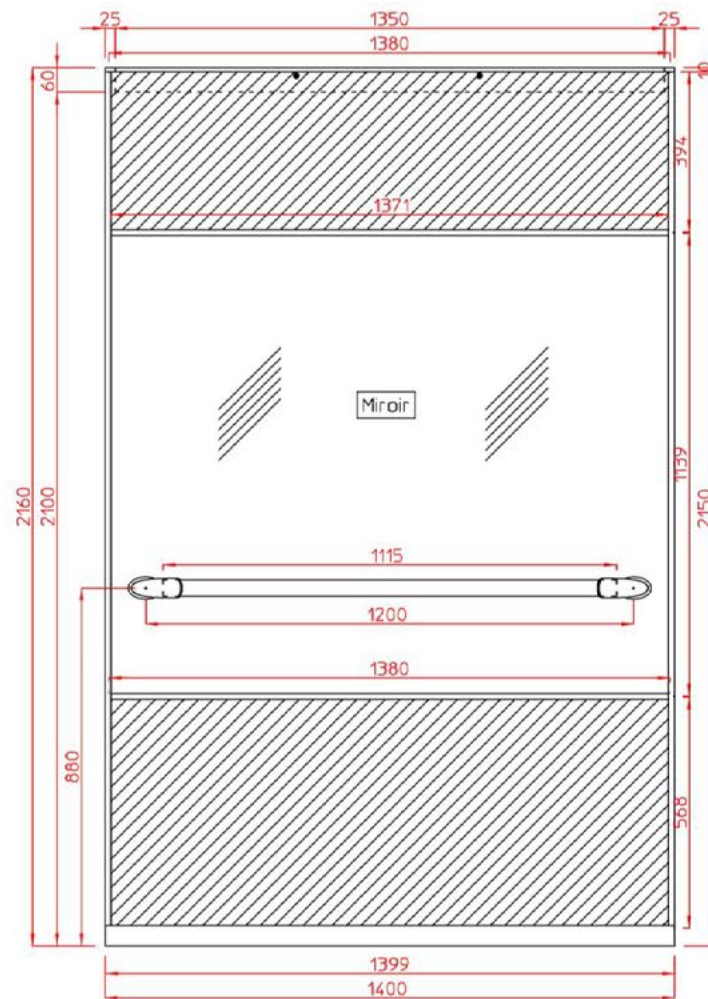

Face B

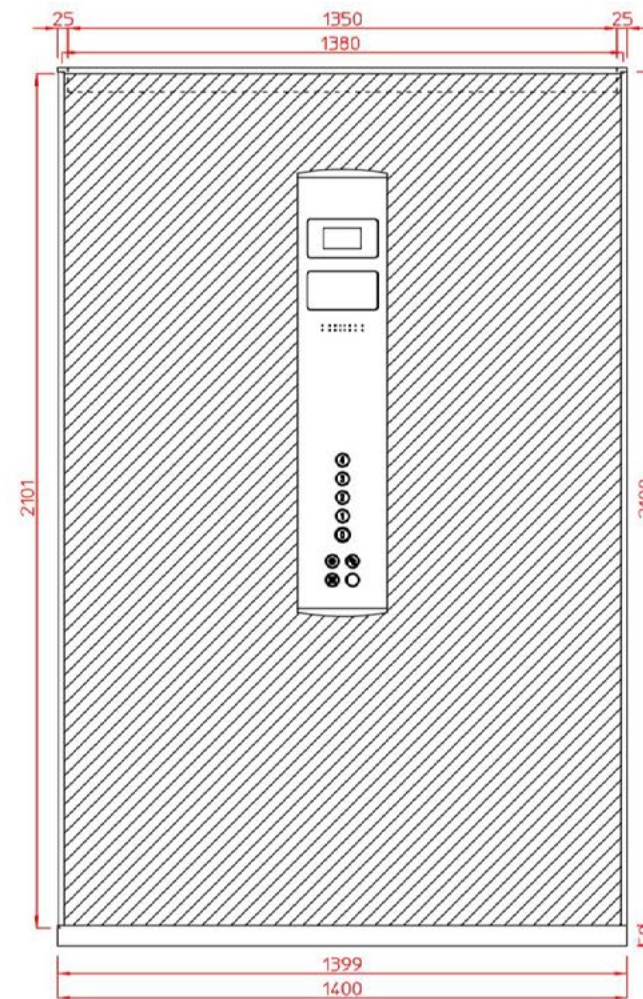

Face D

Option Lacobel – *Lacobel option*



Sol
Floor

Tapis gris stone
PVC - Gris stone

Stratifié
Laminated panel

Abet 0509 pixel + Lacobel White pure 9003 **[Option]**
Abet 0509 pixel + White pure 9003 lacobel [Option]

Faux plafond
False ceiling

Blanc RAL 9003 avec spots carrés à LED **[Option]**
White epoxy RAL 9003 with 4 square LED spots [Option]

Main courante
Handrails

Tube aluminium aspect inox, embout poli brillant
Tube aluminium stainless steel aspect, ends polished brightness aluminium

Miroir
Mirror

Toute largeur hauteur 500
Full width height 500 mm

Boîte à boutons
Car operating panel

Demi colonne M3 en Inox brossé
Half height column M3 in brushed stainless steel

Option Lacobel – *Lacobel option*



Sol
Floor

Tapis herringbone châtain
PVC - Herringbone châtain

Stratifié
Laminated panel

Arpa 0623 + Lacobel Copper métal 9115 **[Option]**
Arpa 0623 + Copper métal 9115 lacobel [Option]

Faux plafond
False ceiling

Blanc RAL 9003 avec bandes à LED **[Option]**
White epoxy RAL 9003 with LED strips [Option]

Main courante
Handrails

Tube aluminium aspect inox, embout poli brillant
Tube aluminium stainless steel aspect, ends polished brightness aluminium

Miroir
Mirror

Toute largeur hauteur 1000 **[Option]**
Full width Height 1000 mm [Option]

Boîte à boutons
Car operating panel

Demi colonne M3 en Inox brossé
Half height column M3 in brushed stainless steel

Option Lacobel – *Lacobel option*



Sol
Floor

Tapis Urban souris
PVC - Urban souris

Stratifié
Laminated panel

Arpa 9233 larix + Lacobel green soft **[Option]**
Arpa 9233 larix + green soft Lacobel [Option]

Faux plafond
False ceiling

Blanc RAL 9003 avec spots ronds à LED
White epoxy RAL 9003 with 4 round LED spots

Main courante
Handrails

Tube aluminium aspect inox, embout poli brillant
Tube aluminium stainless steel aspect, ends polished brightness aluminium

Miroir
Mirror

Toute largeur hauteur 500
Full width height 500 mm

Boîte à boutons
Car operating panel

Demi colonne M3 en Inox brossé
Half height column M3 in brushed stainless steel

Option Lacobel – *Lacobel option*



Sol
Floor

Céramique béton **[Option]**
Béton ceramic [Option]

Main courante
Handrails

Tube aluminium aspect inox, embout poli brillant
Tube aluminium stainless steel aspect, ends polished brightness aluminium

Stratifié
Laminated panel

Arpa 3346 ker + Lacobel anthracite 7016 **[Option]**
Arpa 3346 ker + anthracite 7016 Lacobel [Option]

Miroir
Mirror

Toute largeur hauteur 1000 **[Option]**
Full width Height 1000 mm [Option]

Faux plafond
False ceiling

Blanc RAL 9003 avec spots carrés à LED **[Option]**
White epoxy RAL 9003 with 4 square LED spots [Option]

Boîte à boutons
Car operating panel

Demi colonne M3 en Inox brossé
Half height column M3 in brushed stainless steel

Option impression - *Printed Option*



Sol
Floor

Céramique Blanco carrara **Option**
Blanco carrara Ceramic Option

Stratifié
Laminated panel

Arpa 3310 Ghibli + impression **Option**
Arpa 3310 Ghibli + printed Option

Faux plafond
False ceiling

Blanc RAL 9003 avec spots carrés à LED **Option**
White epoxy RAL 9003 with 4 square LED spots Option

Main courante
Handrails

Tube aluminium aspect inox, embout poli brillant
Tube aluminium stainless steel aspect, ends polished brightness aluminium

Miroir
Mirror

Toute largeur hauteur 1000 **Option**
Full width Height 1000 mm Option

Boîte à boutons
Car operating panel

Demi colonne M3 en Inox brossé
Half height column M3 in brushed stainless steel

Option impression - *Printed Option*

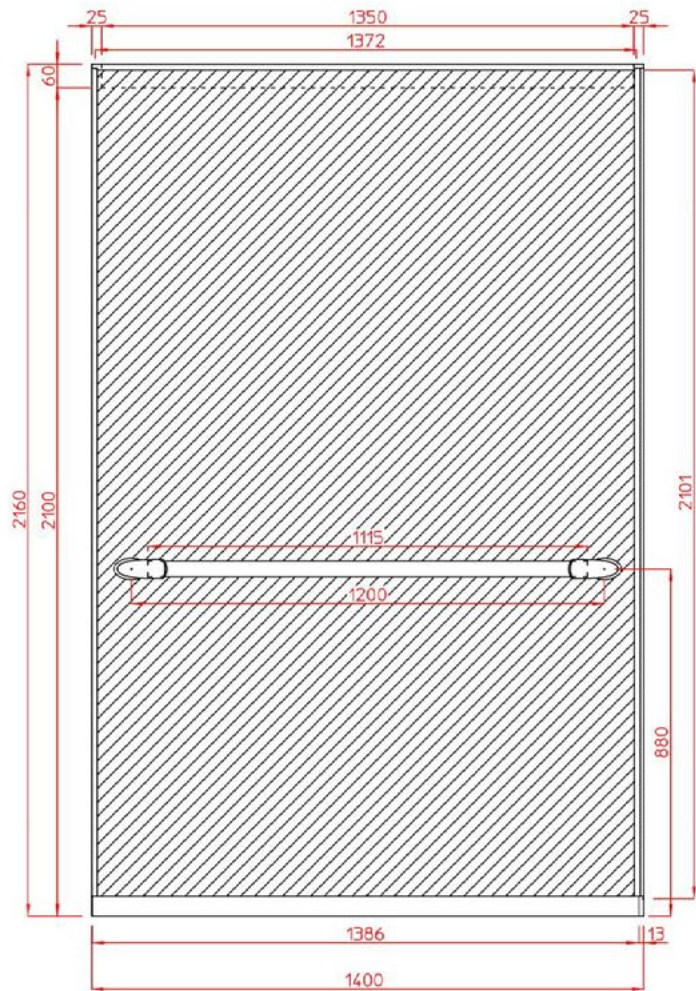

Face B

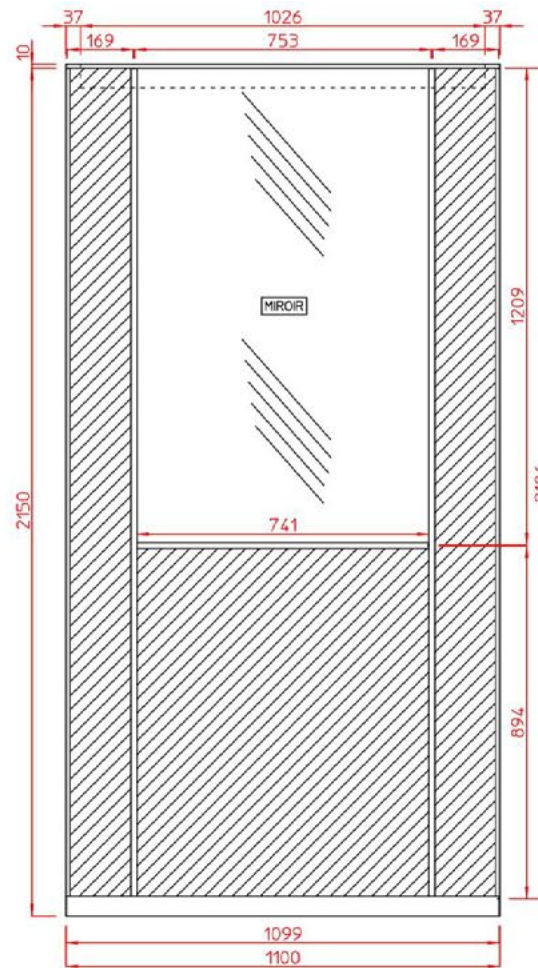

Face C

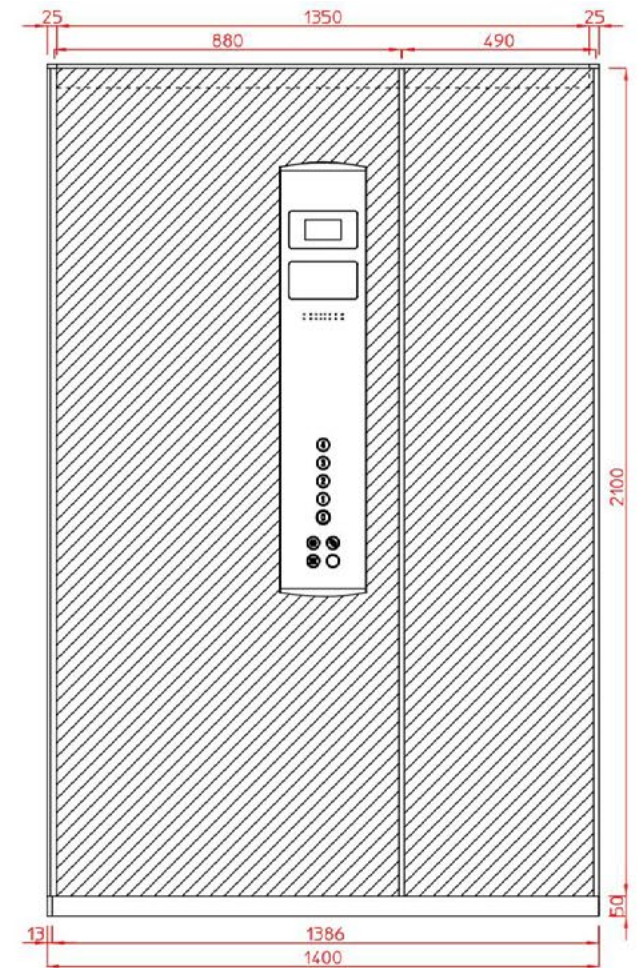

Face D



Sol
Floor

Tapis gris stone
PVC - Gris stone

Stratifié
Laminated panel

Abet 634 + Arpa 2631 Lucida
Abet 634 + Arpa 2631 Lucida

Faux plafond
False ceiling

Blanc RAL 9003 avec spots ronds à LED
White epoxy RAL 9003 with 4 round LED spots

Main courante
Handrails

Tube aluminium aspect inox, embout poli brillant
Tube aluminium stainless steel aspect, ends polished brightness aluminium







Miroir
Mirror

Largeur 2/3 toute hauteur **[Option]**
width 2/3 full height [Option]

Boîte à boutons
Car operating panel

Demi colonne M3 en Inox brossé
Half height column M3 in brushed stainless steel



Sol <i>Floor</i>	 Céramique pierre bleue (Option) <i>Pierre bleue ceramic (Option)</i>	Main courante <i>Handrails</i>	 Tube aluminium aspect inox, embout poli brillant <i>Tube aluminium stainless steel aspect, ends polished brightness aluminium</i>
Stratifié <i>Laminated panel</i>	 Abet 669 + Abet 850 <i>Abet 669 + Abet 850</i>	Miroir <i>Mirror</i>	 Largeur 2/3 toute hauteur (Option) <i>width 2/3 full height (Option)</i>
Faux plafond <i>False ceiling</i>	 Blanc RAL 9003 avec spots carrés à LED (Option) <i>White epoxy RAL 9003 with 4 square LED spots (Option)</i>	Boîte à boutons <i>Car operating panel</i>	 Demi colonne M3 en Inox brossé <i>Half height column M3 in brushed stainless steel</i>

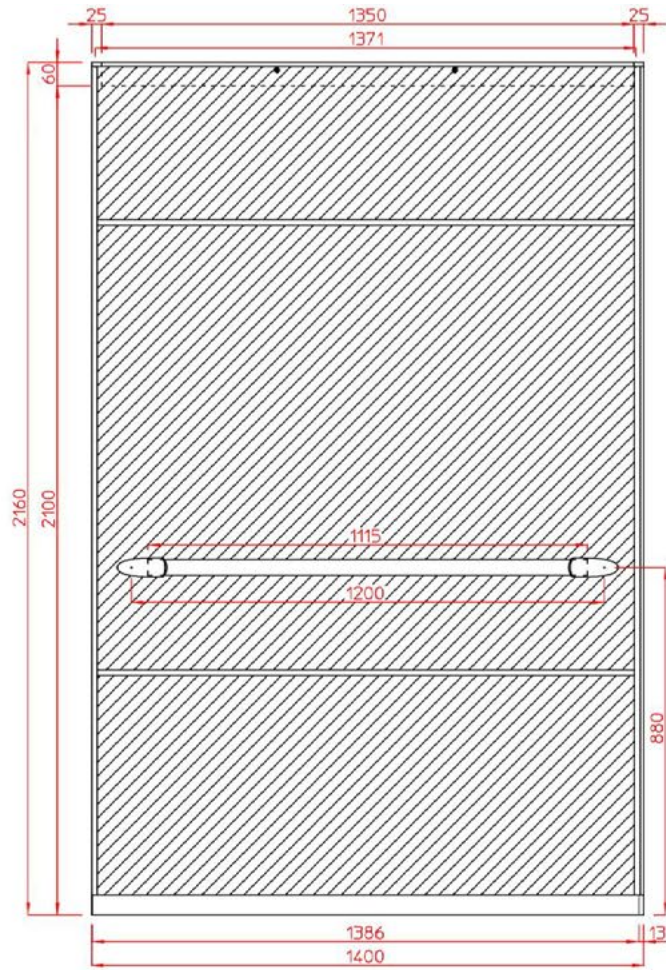

Face B

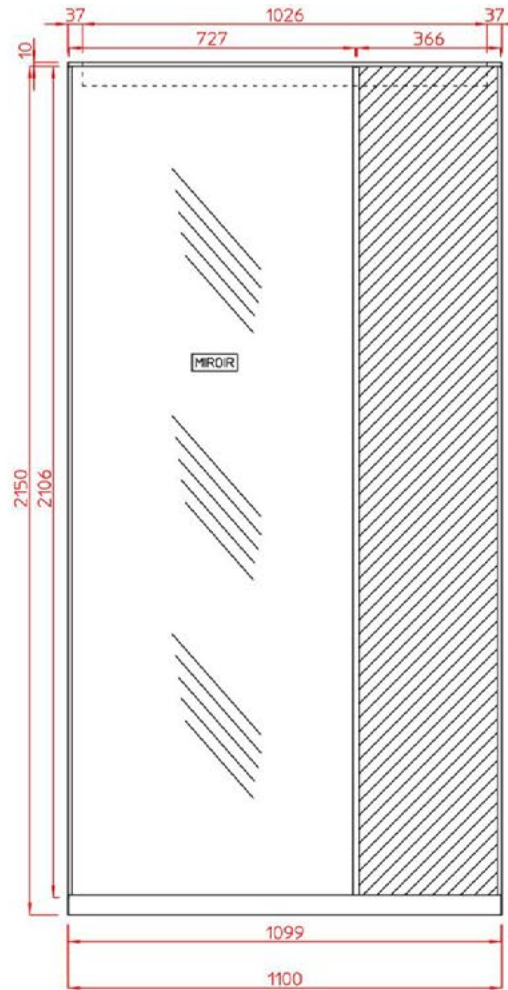

Face C

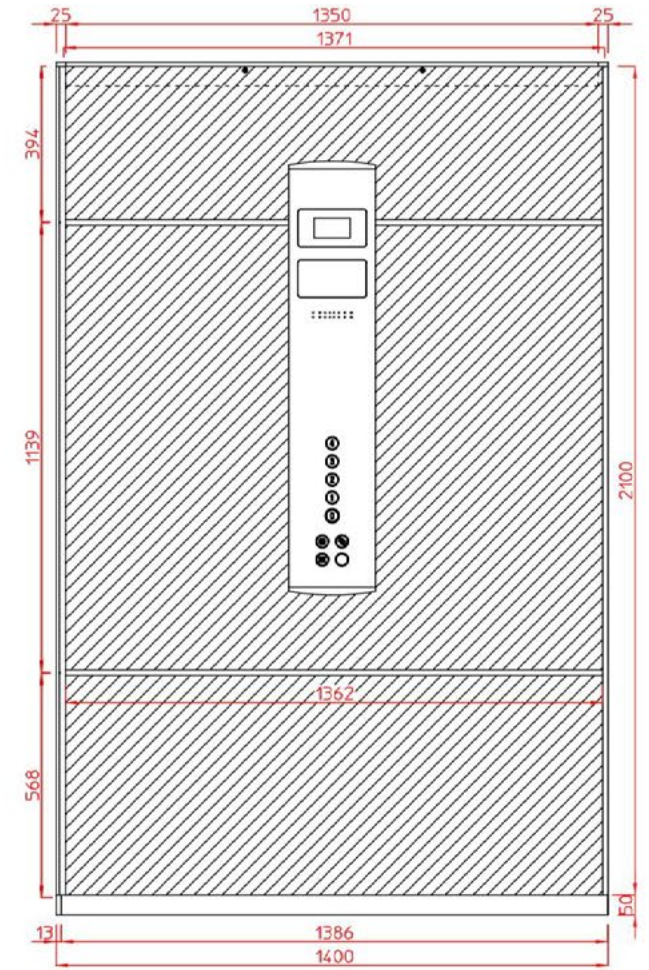

Face D



634

2631

2631



2012

Lineha - option Lacobel
Lineha - Lacobel option

White pure



669

Cendre

Lineha - option béton ciré
Lineha - polished concrete option





SODIMAS®

ascenseurs



Siège social - Head office

📍 11 rue Ampère
26600 Pont de l'Isère
FRANCE

☎ +33(0)4 75 84 86 00
@ accueil@sodimas.fr

www.SODIMAS.com